

CS12 END VIEW (P1)

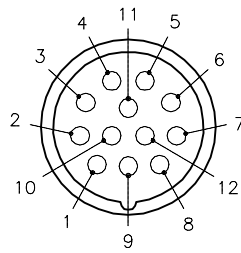

- 1 = PORT 1-1
- 2 = PORT 1-2
- 3 = PORT 2-1
- 4 = PORT 2-2
- 5 = PORT 3-1
- 6 = PORT 3-2
- 7 = PORT 4-1
- 8 = PORT 4-2
- 9 = N/C
- 10 = N/C
- 11 = SHIELD
- 12 = GROUND

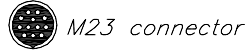

FEMALE END VIEW (J1-J4)

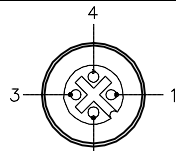

- 1 = V-
- 2 = V+
- 3 = SHD
- 4 = GND



SPECIFICATIONS

HOUSING MATERIAL	DIE-CAST ALUMINUM ALLOY
HOUSING FINISH/COLOR	POWDER COAT/BLACK
RECEPTACLE HOUSINGS (J1-J4)	BRASS/NICKEL
RECEPTACLE HOUSING (P1)	BRASS/NICKEL
CONTACT CARRIERS/COLOR (J1-J4)	NYLON/BLACK
CONTACT CARRIER/COLOR (P1)	PBT/WHITE
CONTACTS	BRASS/GOLD
RATED CURRENT [A]	4.0 AMPS
RATED VOLTAGE [V]	150 V
PROTECTION CLASS to DIN 40050	IP 67 - ONLY WHEN ALL RECEPTACLES ARE COVERED WITH PLUGS OR CONNECTED
OPERATING TEMPERATURE	-40°C to 90°C (-40°F to 194°F)

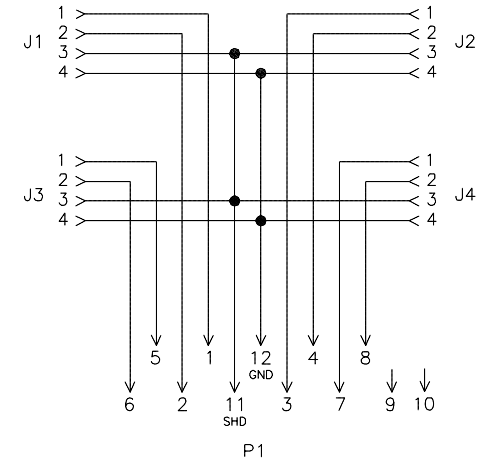
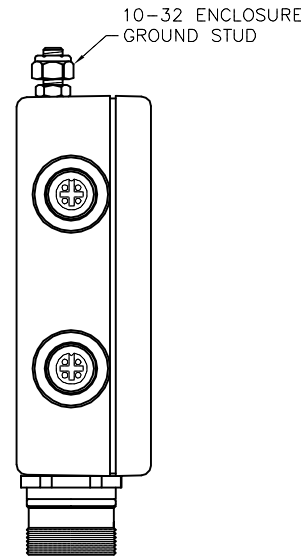
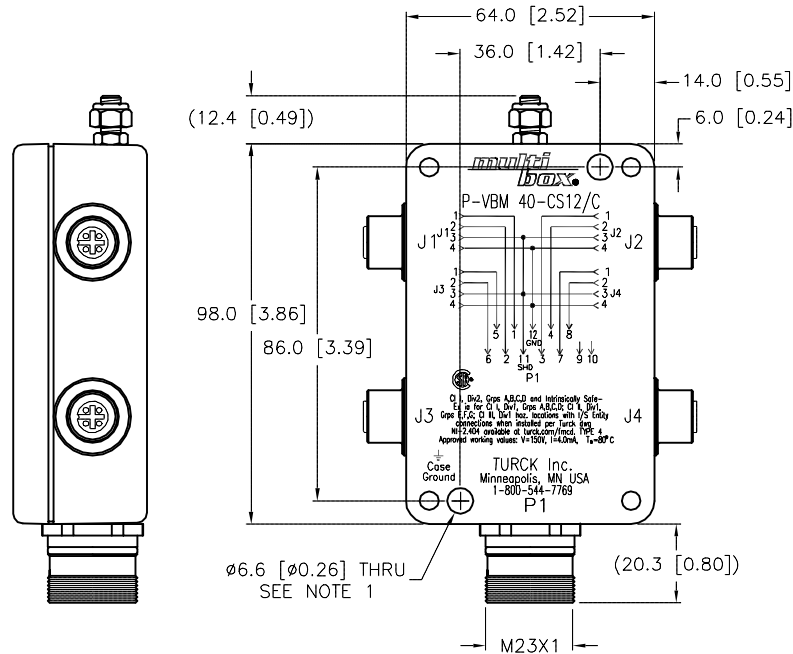

WIRING DIAGRAM

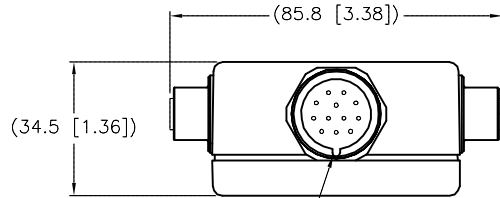

KEYWAY CAN BE AT ANY POSITON

NOTES:

- 1. CLEARANCE HOLE FOR 1/4-20 MOUNTING SCREWS (2 NOT INCLUDED).

SOURCE DRAWING - FOR REFERENCE ONLY

RELATED DOCUMENTS 1. 2. 3. 4.	3RD ANGLE PROJECTION 	THIS DRAWING IS CONFIDENTIAL AND THE PROPERTY OF TURCK INC. USE OF THIS DOCUMENT WITHOUT WRITTEN PERMISSION IS PROHIBITED.		3000 CAMPUS DRIVE MINNEAPOLIS, MN 55441 1-800-544-7769 (763) 553-7300 (763) 553-0708 fax turck.com	
		DRFT	RWC	DATE	03/13/07
MATERIAL SEE SPECIFICATIONS	ALL DIMENSIONS DISPLAYED ON THIS DRAWING ARE FOR REFERENCE ONLY	APVD		SCALE	1=2.0
FINISH SEE SPECIFICATIONS		CONTACT TURCK FOR MORE INFORMATION	UNIT OF MEASUREMENT <b>MILLIMETER [ INCH ]</b>		IDENTIFICATION NO. U2-10252
DO NOT SCALE THIS DRAWING		FILE: U2-10252		SHEET 1 OF 1	

B	UPDATE VOLTAGE AND CURRENT RATINGS	RDS	06/27/14	46127
REV	DESCRIPTION	BY	DATE	ECO NO.